

PROFITEST PRIME, PRIME AC

3-349-934-26
5/3.19

D

Bitte lesen Sie unbedingt die ausführliche Bedienungsanleitung im Format PDF unter www.gossenmetrawatt.com. Die Kurzbedienungsanleitung beschreibt nur die Basisfunktionen der Serie PROFITEST PRIME und ersetzt nicht die ausführliche Bedienungsanleitung!

GB

Please make sure to read the detailed operating instructions in pdf format at www.gossenmetrawatt.com. The short-form instructions describe only the basic functions of the PROFITEST PRIME series and are no substitute for the detailed instructions!

I

Si prega di leggere le istruzioni per l'uso dettagliate in formato PDF sul sito www.gossenmetrawatt.com. La guida rapida descrive solo le funzioni di base della serie PROFITEST PRIME e non sostituisce le istruzioni per l'uso dettagliate.

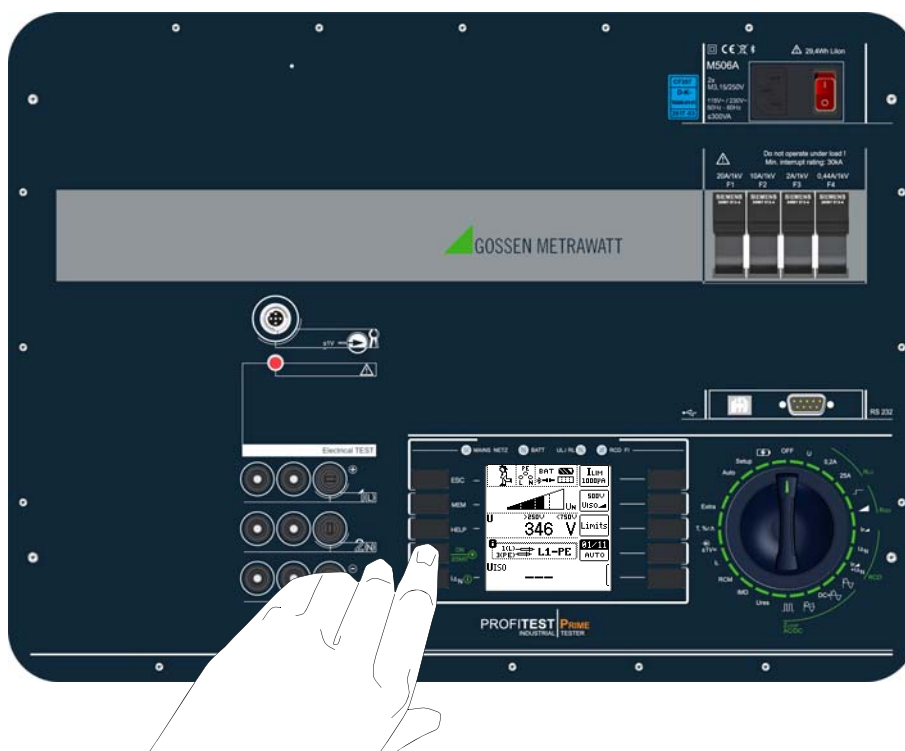

Prüfgerät nur unter Leitung und Aufsicht einer Elektrofachkraft betreiben!



Test instrument may only be operated under supervision of a qualified electrician!



Utilizzare lo strumento solo sotto la sorveglianza di un esperto in materia elettrotecnica !

D

GB

F

E

I

NL

**1 Einschalten,
2 Akkutest
3 Akkus
schnellladen**

**Switching on,
Battery test
Fast charging
of batteries**

**Activation,
Test de piles rech.
Chargement
rapide des piles**

**Conectar,
Prueba de baterías
Carga rápida
de baterías**

**Accendere,
Test batterie
Carica rapida
delle batterie**

**Inschakelen
Batterijtest
Snel opladen
van batterijen**

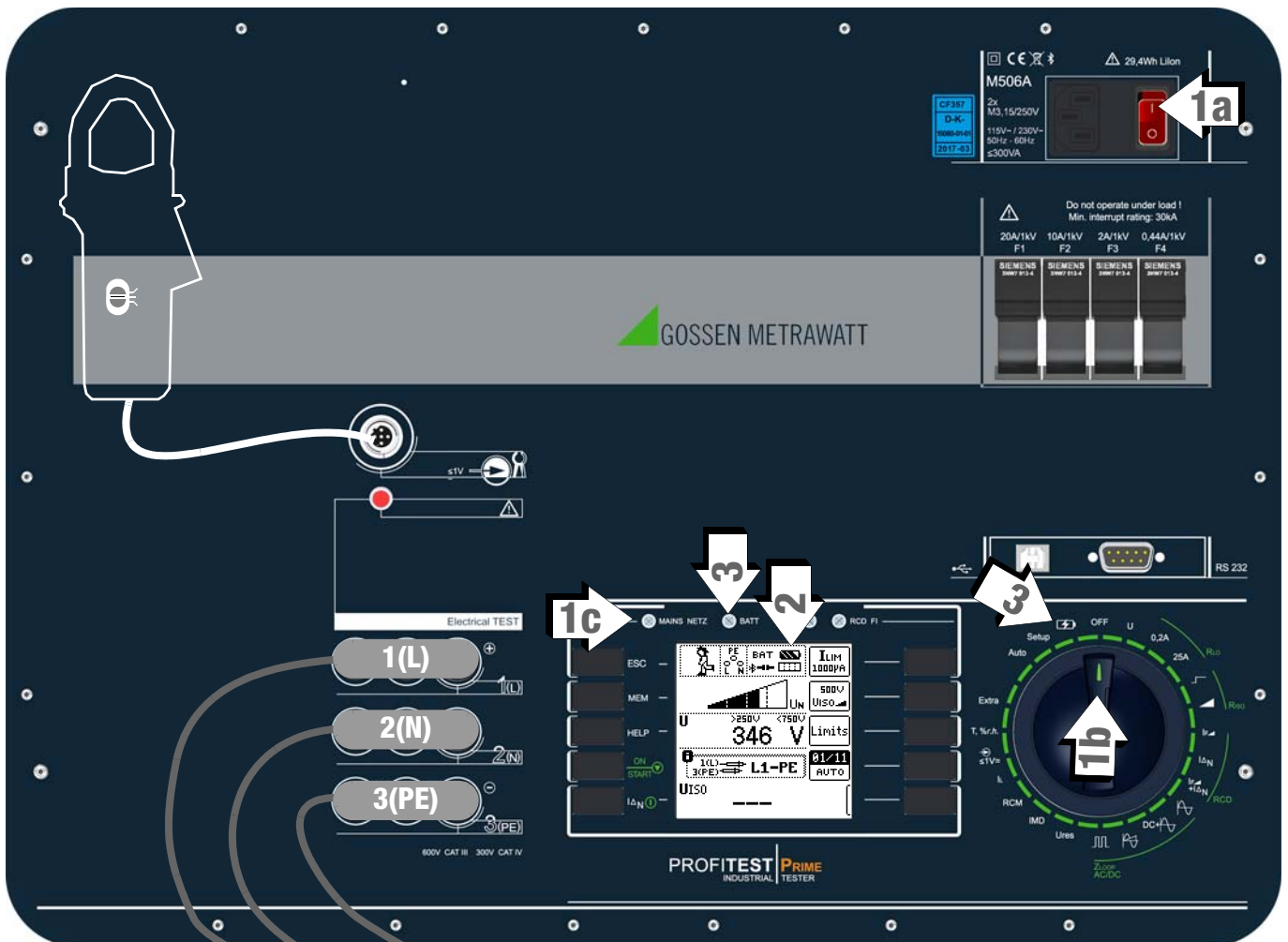
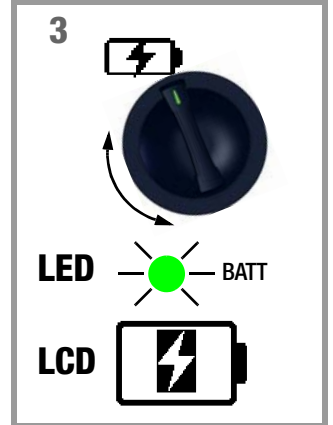
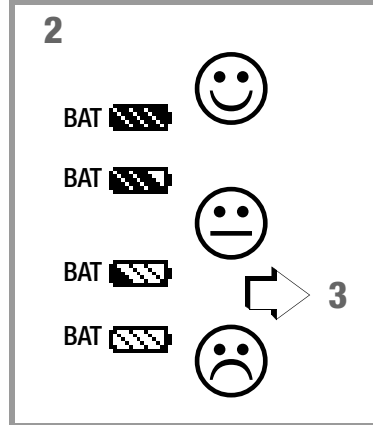
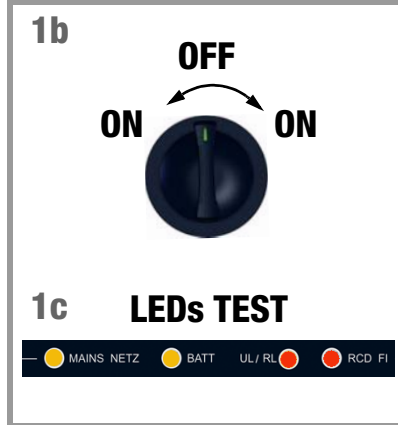
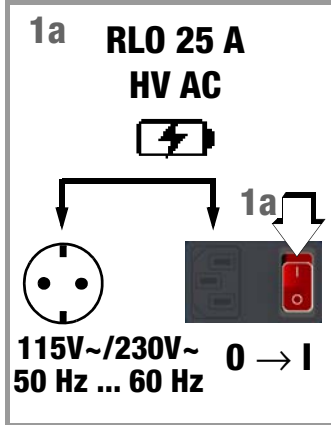

1(L) – L1

2(N) – L3

3(PE) – L2

(D)	(GB)	(F)	(E)	(I)	(NL)
1(L) – 2(N) – 3(PE) Anschluss- test	Connection test	Test de connexion	Prueba de conexión	Test collegamento	Aansluittest

(D)	(GB)	(F)	(E)	(I)	(NL)
1 Helligkeit 2 Kontrast 3 Hilfe anfordern	Brightness Contrast Request help	Intensité lumineuse Contraste Demander aide	Brillo Contraste Solicitar help	Luminosità Contrasto Chiedere aiuto	Helderheid Contrast Hulp inroepen

(D)	(GB)	(F)	(E)	(I)	(NL)
Parameter: 1-3 auswählen 4 bestätigen 5 übernehmen	Parameter: select confirm take over	Paramètres sélectionner confirmer reprendre	Parámetros seleccionar confirmar aceptar	Parametro selezionare confermare applicare	Parameter kiezen bevestigen accepteren

(D)

(GB)

(F)

(E)

(I)

(NL)

Messung

- 1 auswählen
- 2 starten
- 3 RCD auslösen
- 4 speichern

Measurement

- 1 select
- 2 start
- 3 trip RCD
- 4 store

Mesure

- 1 sélection
- 2 démarrer
- 3 déclencher RCD
- 4 mémoriser

Medida

- 1 seleccionar
- 2 iniciar
- 3 iniciar RCD
- 4 almacenar

Misura

- 1 selezionare
- 2 avviare
- 3 sganciare RCD
- 4 salvare

Meting

- 1 kiezen
- 2 starten
- 3 RCD activeren
- 4 opslaan

1



U

RLO – 0,2 A

RLO – 25 A

RISO – □ Konstant

RISO – ▲ Rampe

RCD – IF▲

RCD – IΔN

RCD – IF+ IΔN

Loop –

Loop – DC+

Loop –

Loop –

Ures

IMD

RCM

IL

⊖ ≤1V≅ (Sensor)

T %r.H.

Extra ↓



- U(ZLN)
- RCD
- PRCD

HV (PRIME AC)

Auto

Setup



D: Schnell laden

GB: Fast charge

F: Chargement rapide

E: Carga rápida

I: Carica rapida

NL: Snel opladen

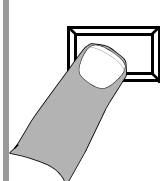

2

ON START

3

IΔN

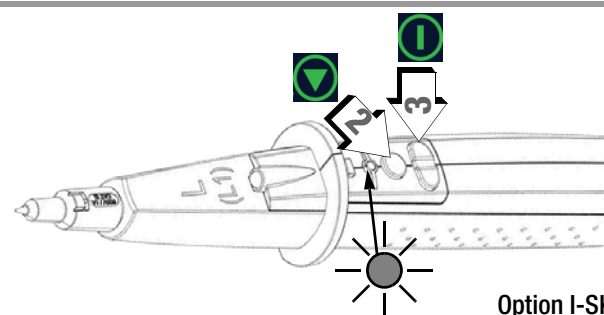

Option I-SK4/12-PROFITEST PRIME (Z506T/U)

3-349-971-15

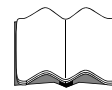

Bedienungsanleitung
Operating Instructions

2

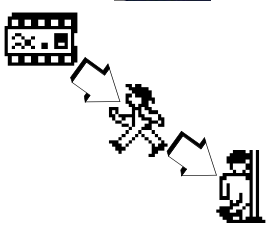



Option I-SK4/12-PROFITEST PRIME (Z506T/U)

			gelb / yellow
			grün / green
			rot / red

3x

3



RCD → OK

RCD → RCD•FI



4

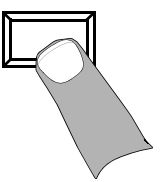

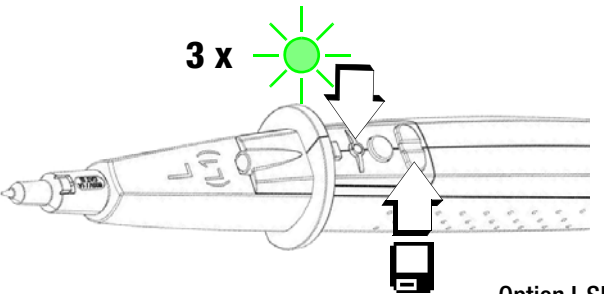

Option I-SK4/12-PROFITEST PRIME (Z506T/U)

$U (U_{L-N} / U_{L-PE} / U_{N-PE})$
f

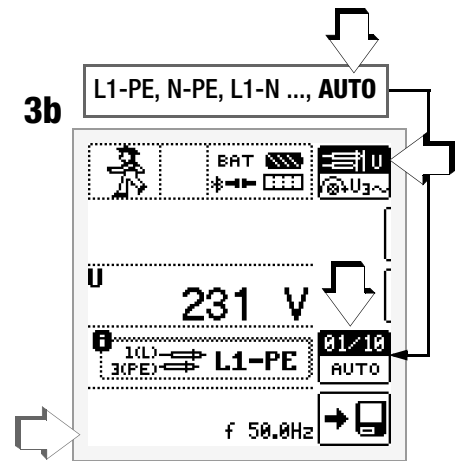
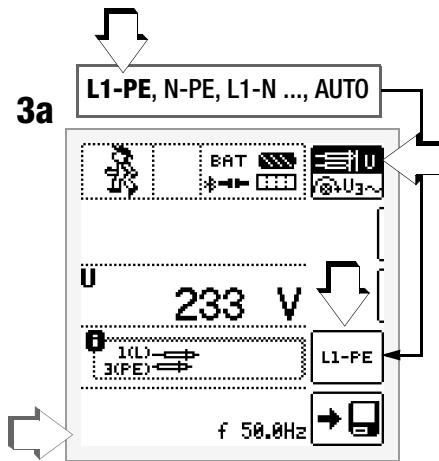
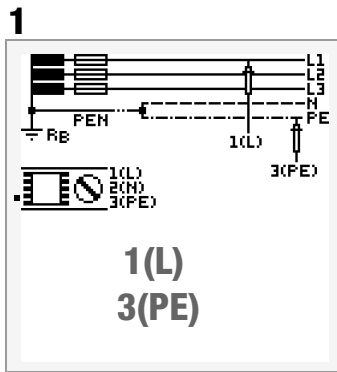

- | | | | | | |
|------------------------|------------------------------|-------------------------------|-------------------------|-----------------------------|-------------------------|
| (D) | (GB) | (F) | (E) | (I) | (NL) |
| U3~
Drehfeld | U3~
Phase sequence | U3~
Champs tournant | U3~
Trifásico | U3~
Senso ciclico | U3~
Draaiveld |

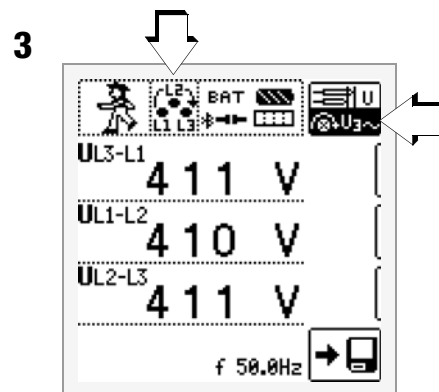
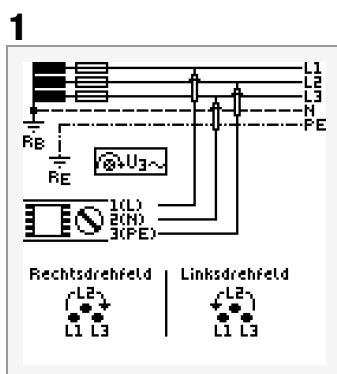

L1: 1(L)
L3: 2(N)
L2: 3(PE)



<p>Rechtsdrehfeld Right rotation Rotation à droite Sentido de giro normal Senso ciclico DX Rechts draaiveld</p>	<p>Linksdrehfeld Left rotation Rotation à gauche Sentido de giro inverso Senso ciclico SX Links draaiveld</p>
--	--

RLO/RISO

RLO/RISO

RLO/RISO

RLO/RISO

RLO/RISO

RLO/RISO



Folgende Messungen sind nur an spannungsfreien Messobjekten möglich. Fremdspannung sperrt die Messung!

The following measurements are only possible on voltage-free devices. Interference voltage disables the measurement!

Les mesures suivantes ne sont possibles qu'avec des appareils sans tension. La tension étrangère empêche la mesure!

Las siguientes mediciones son factibles sólo sobre objetos exentos de tensión. La tensión ajena bloquea la medición!

Le seguenti misure sono possibili soltanto se l'oggetto da misura è privo di tensione. Le tensioni esterne impediscono la misura!

De volgende metingen zijn alleen aan spanningsloze meetobjecten mogelijk. Stoorspanning blokkeert de meting!

RLO 0,2A

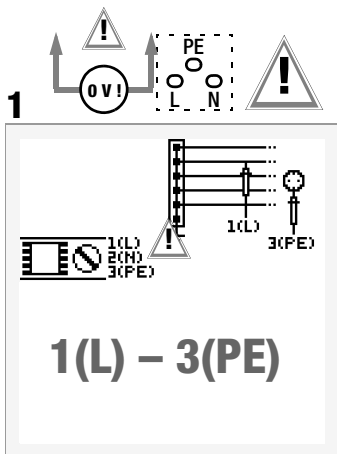

ON ⇒ RLO = RLO - ROFFSET

ton RLO+ ↔ RLO- POL → PE
RLO+ POL → PE
RLO- POL → PE

ton RLO+ ↔ RLO- POL → PE
RLO+ POL → PE
RLO- POL → PE

PRCD TEST

ton = AUTO, 1 min, 5 min

RLO PE BAT ton: LAUTO
L N → RLO → PE

RLO <1.00Ω Ω → PE

Limits

ROFFSET ON OFF

ROFFSET 0.03 Ω

extension cable ⇒ ROFFSET

R < 10 Ω

START

RLO <1.00Ω
0.00 Ω

ton: LAUTO
→ PE

Limits

ROFFSET ON OFF

ROFFSET 0.03 Ω

RLO 25 A

115V~/230V~
50 Hz ... 60 Hz

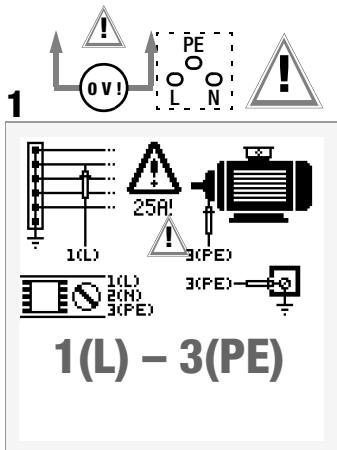

ROFFSET = ON
⇒ RLO = RLO - ROFFSET

RLO PE BAT ton: LAUTO
L N → RLO → PE

RLO <1.00Ω I HIGH Ω

I A Limits

ROFFSET ON OFF

ROFFSET 10mΩ

extension cable ⇒ ROFFSET

R < 10 Ω

START

RLO <1.00Ω I HIGH
7mΩ

I A Limits

ROFFSET ON OFF

ROFFSET 10mΩ

RISO (RINS)

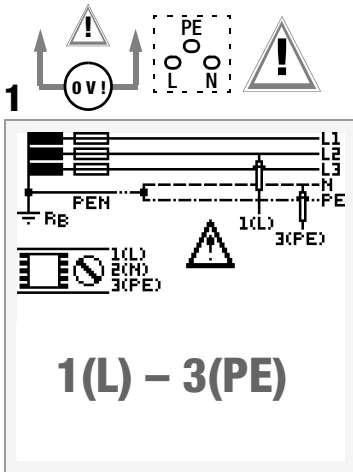

2



3a

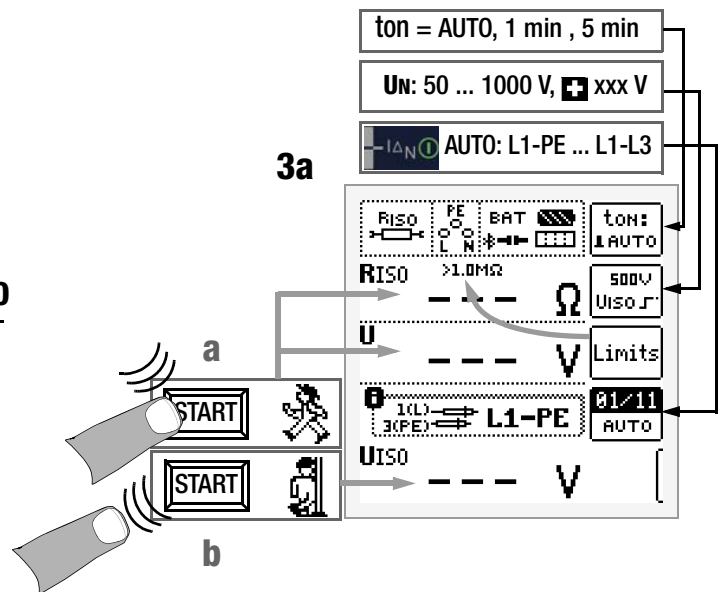

RISO (RINS)

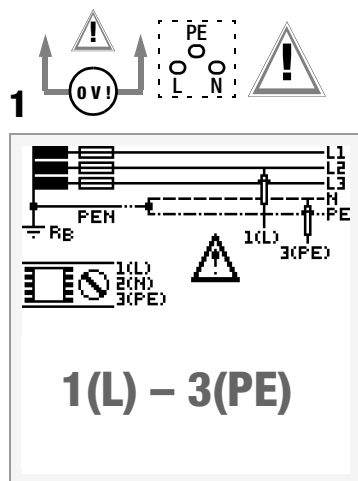

2



3b

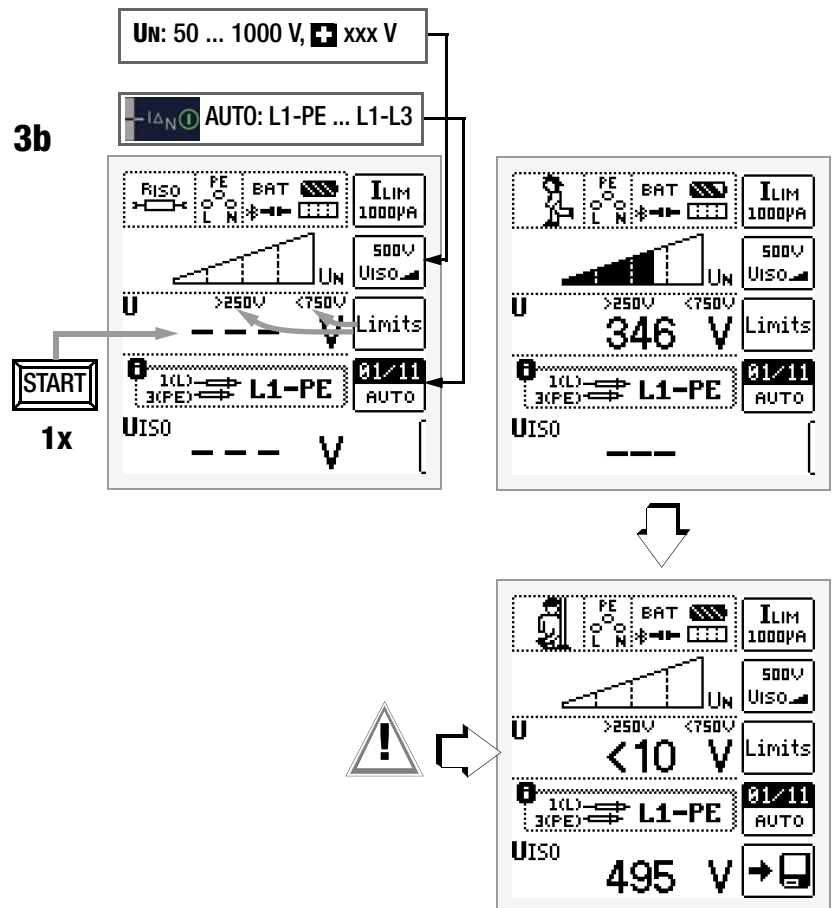

RCD I_{Δ}

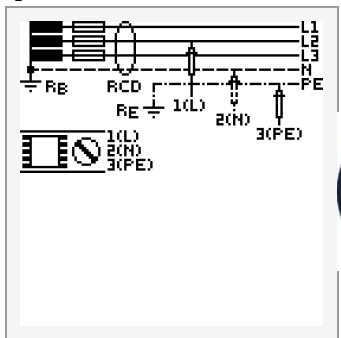
1 

2 

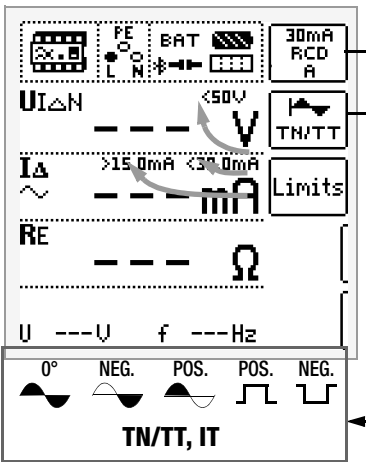
3 

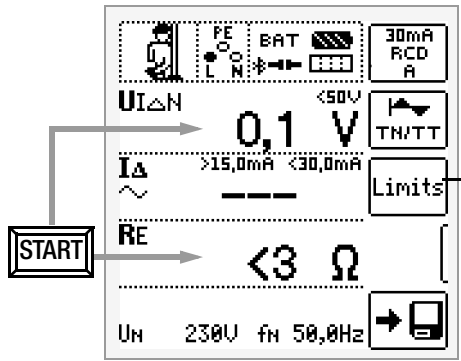
4 

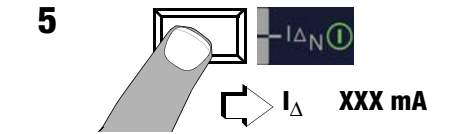
5 

UI Δ N <50V
I Δ >15,0mA <30,0mA
RE --- Ω
U ---V **f** ---Hz
TN/TT, IT 0° NEG. POS. POS. NEG.

UL < 25 V, 50 V, 65 V, \square xx V
I Δ > 1.0 ... 250 mA, \square xxx mA
I Δ < 6.0 ... 1.00 A, \square xxx mA

START

I Δ XXX mA

RCD $I_{\Delta N}$

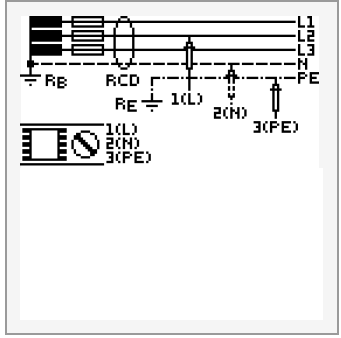
1 

2 

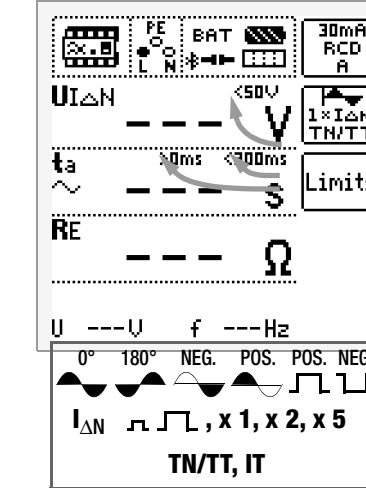
3 

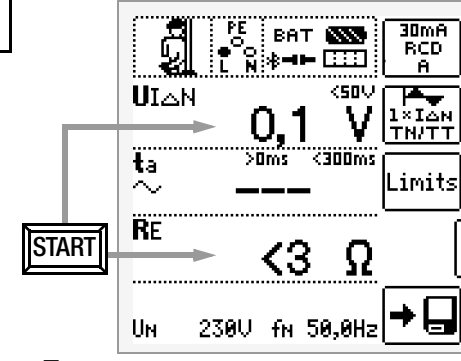
4 

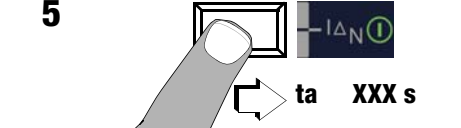
5 

UI Δ N <50V
ta >0ms <300ms
RE --- Ω
U ---V **f** ---Hz
TN/TT, IT 0° 180° NEG. POS. POS. NEG.
I Δ N \square , x 1, x 2, x 5

UL < 25 V, 50 V, 65 V, \square xx V
ta < 40 ms... 1.00 s, \square xxx ms
ta > 0 ms... 500 ms, \square xxx ms

START

ta XXX s

RCD I_{Δ} + $I_{\Delta N}$

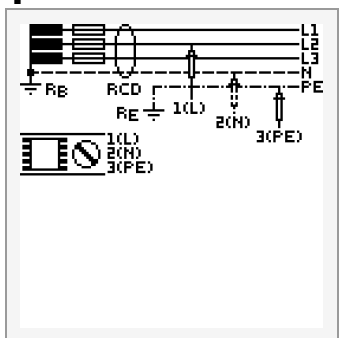
1 

2 

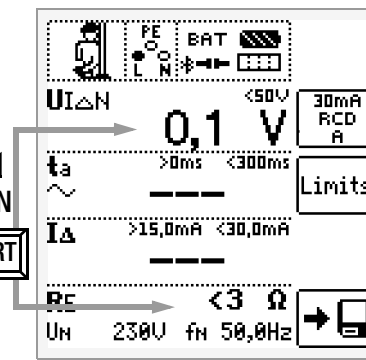
3 

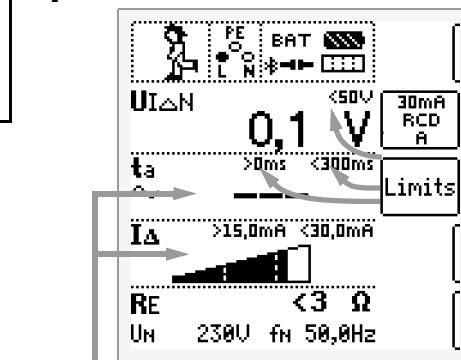
4 

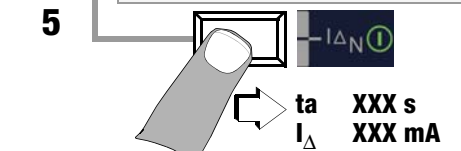
5 

UI Δ N <50V
ta >0ms <300ms
I Δ >15,0mA <30,0mA
RE <3 Ω
U ---V **f** ---Hz
TN/TT, IT 0° 180° NEG. POS. POS. NEG.

UL < 25 V, 50 V, 65 V, \square xx V
ta < 40 ms... 1.00 s, \square xxx ms
ta > 0 ms... 500 ms, \square xxx ms
I Δ > 1.0 ... 2.00 A, \square xxx mA
I Δ < 1.0 ... 2.00 A, \square xxx mA

START

ta XXX s
I Δ XXX mA

ZLOOP \mathbb{A}

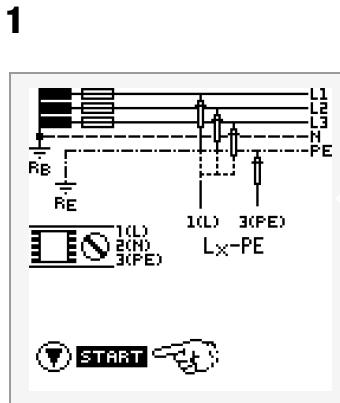

3

IN 2 ... 160 A, \square xxxx A
 Typ H, A, B, L, E, C, G, K, D...
 \varnothing 1,5...70 mm² NY... H0...
 \odot \odot \odot 1, 2, 3 ... 10

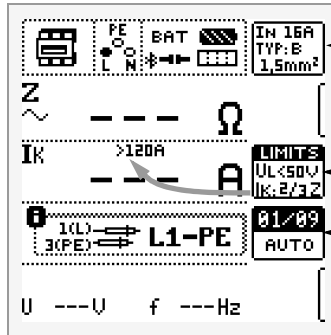

UL < 25, 50, 65 V, \square xx V
 Ik: 2/3 Z, 3/4 Z, Ia, Ia + Δ %

LX-PE, LX-N, LX-LY, AUTO

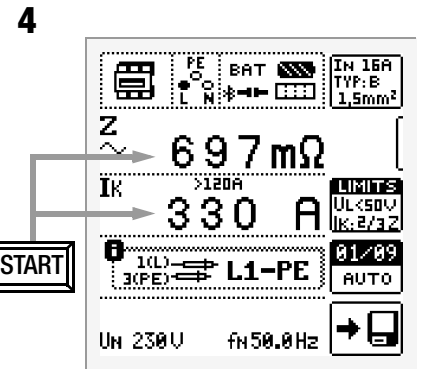

ZLOOP DC+ \mathbb{A}

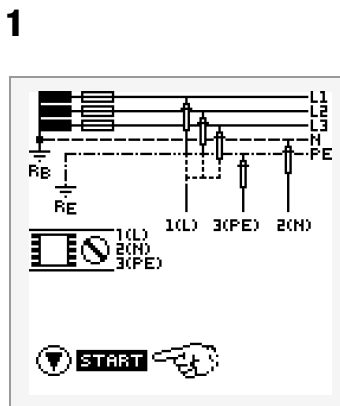

3

IN 2 ... 160 A, \square xxxx A
 Typ H, A, B, L, E, C, G, K, D...
 \varnothing 1,5...70 mm² NY... H0...
 \odot \odot \odot 1, 2, 3 ... 10

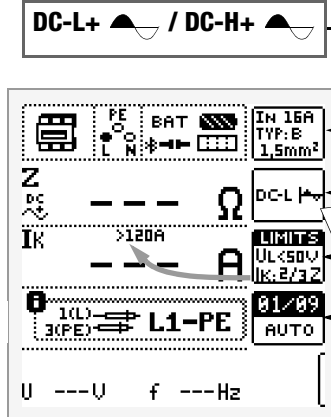

UL < 25, 50, 65 V, \square xx V
 Ik: 2/3 Z, 3/4 Z, Ia, Ia + Δ %

LX-PE, LX-N, LX-LY, AUTO

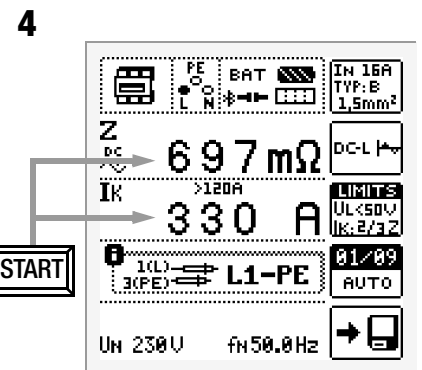

ZLOOP \mathbb{A}

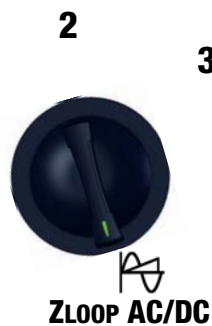
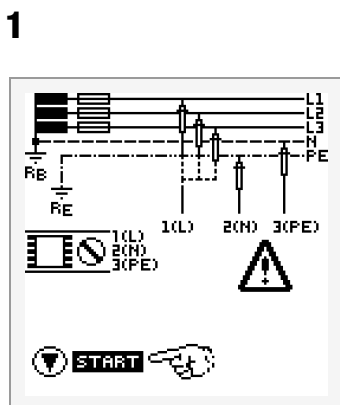

3

IN 2 ... 160 A, \square xxxx A
 Typ H, A, B, L, E, C, G, K, D...
 \varnothing 1,5...70 mm² NY... H0...
 \odot \odot \odot 1, 2, 3 ... 10

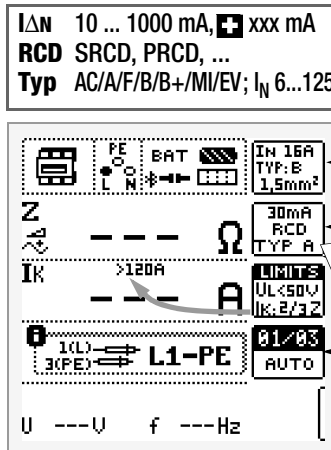

UL < 25, 50, 65 V, \square xx V
 Ik: 2/3 Z, 3/4 Z, Ia, Ia + Δ %

L1-PE, L2-PE, L3-PE, AUTO

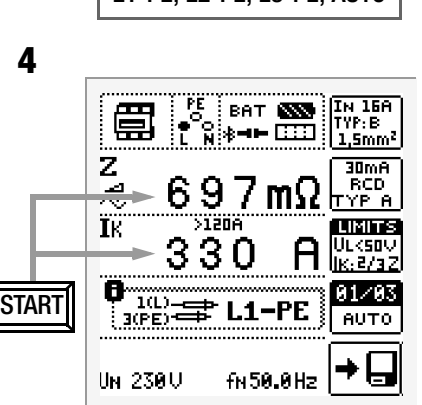

ZLOOP

1

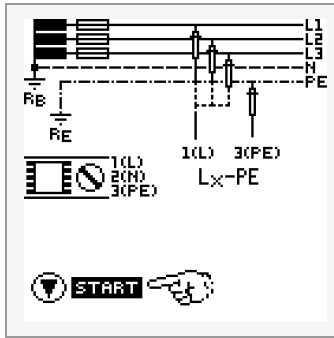



2



ZLOOP AC/DC

3

In 2 ... 160 A,  xxxx A
Typ H, A, B, L, E, C, G, K, D...
 \varnothing 1,5...70 mm² NY... HO...
 1, 2, 3 ... 10

I Δ N 10 ... 1000 mA,  xxx mA
RCD SRCD, PRCD, ...
Typ AC/A/F/B/B+/MI/EV; I_N 6...125 A

IN 16A
 TYP: E
 1,5mm²

30mA RCD TYP A

Z Ω --- Ω

IK >120A --- A

LIMITS
 UL <50V
 Ik: E/a/2

01/09
 AUTO

U ---V f ---Hz

4

UL < 25, 50, 65 V,  xx V
 Ik: 2/3 Z, 3/4 Z, Ia, Ia + Δ %

LX-PE, LX-N, LX-LY, AUTO

IN 16A
 TYP: B
 1,5mm²

30mA RCD TYP A

Z Ω **697 m Ω**

IK >120A **330 A**

LIMITS
 UL <50V
 Ik: E/a/2

01/09
 AUTO

U_n 230V f_n 50.0Hz

Ures

EN 60204:

tu ≤ 5 s → Ures ≤ 60 V !

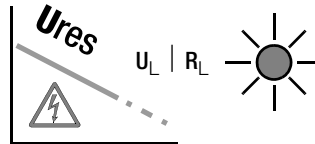

1

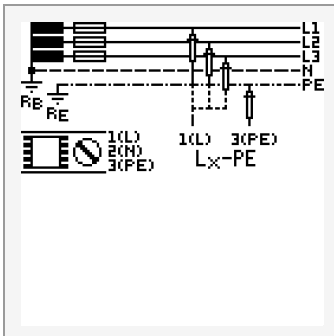

2



Ures

3

BAT MEM 



U 232 V

Ures 0.1 <60V Limits

tu 0.2 s <5s

f 50.0Hz

ESC

ULIM < 60 V,  < xx V
 tu < 5 s,  < xx s

BAT MEM 

U --- V

Ures --- V <60V Limits

tu --- s <5s

f ---Hz

IMD

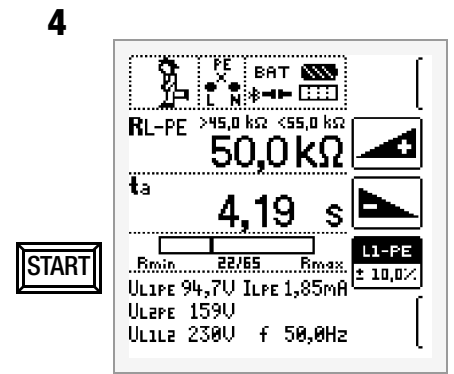
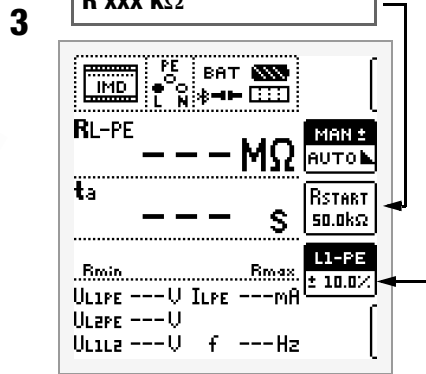
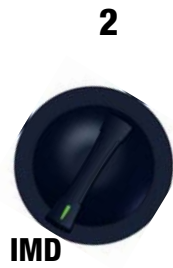
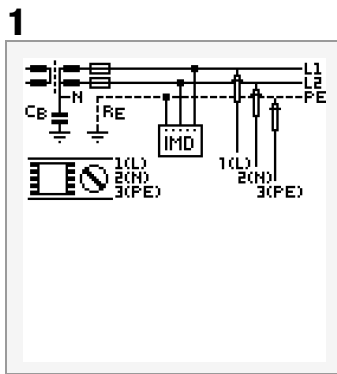

RCM

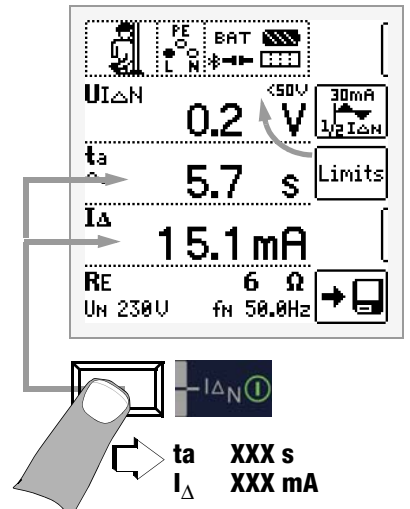
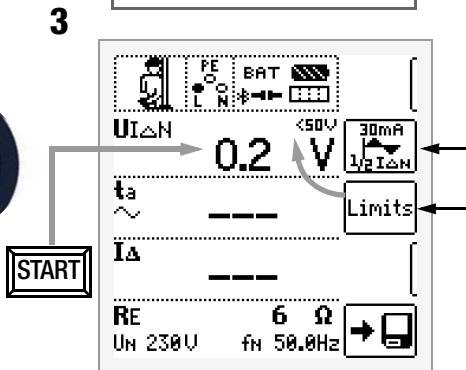
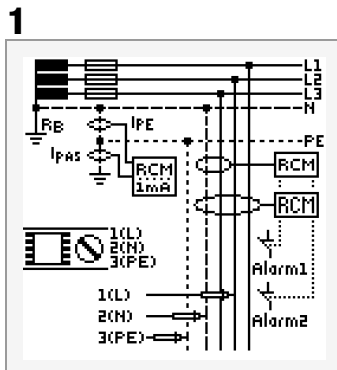

IL

1 Kontaktierung an berührbarer Metall-Fläche

2

3

4

$\oplus \leq 1V \approx$ 3-349-934-26

1

2

3

4

T %r.H.

1

2

3

4

T (Temp)	-10,0 ... +50,0 °C
%r.H. (rHum)	10,0 ... 90,0 %

Extra → ΔU(ZLN) – E-Mobility – PRCD-Test

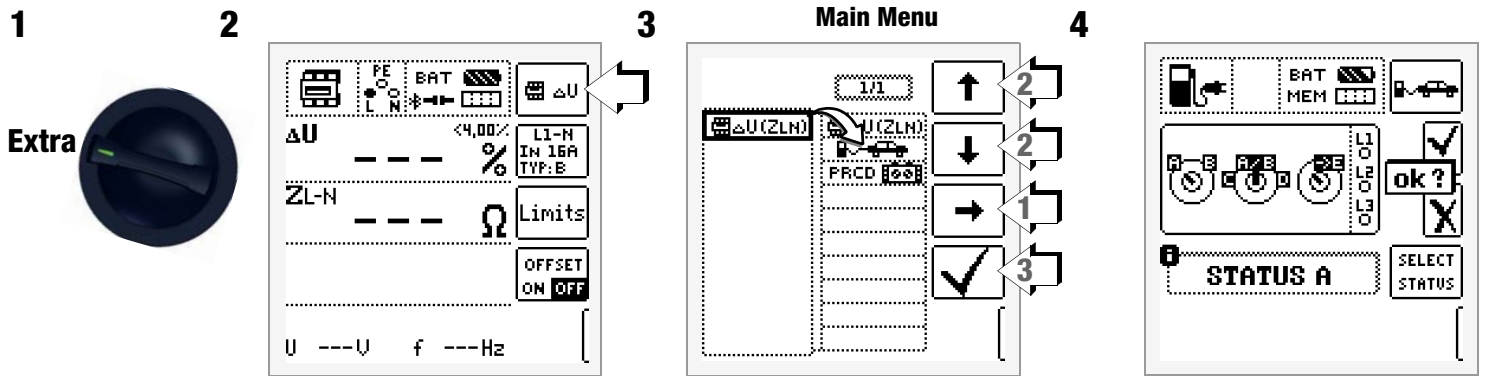

Extra → ΔU(ZLN)

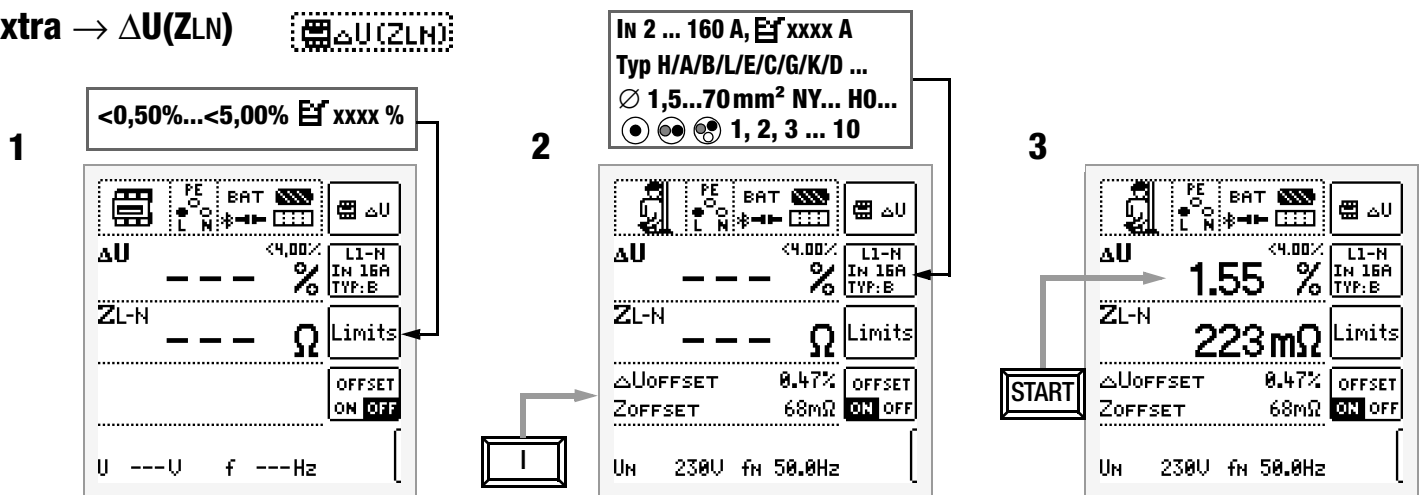

Extra → E-Mobility

Tests per IEC 61851

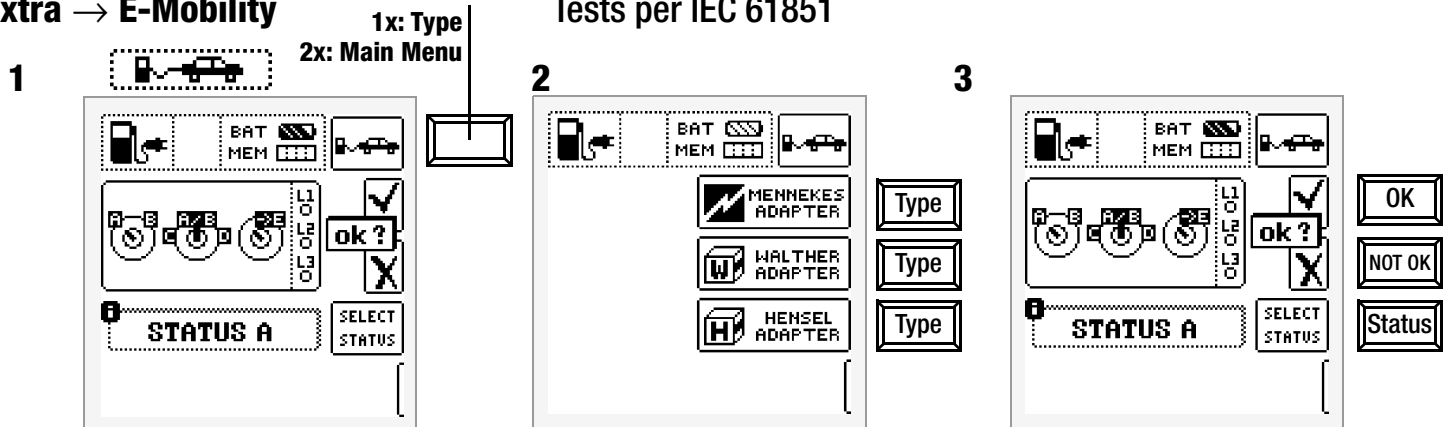

Extra → PRCD-Test → siehe nächste Seite

Extra → PRCD-Test → see next page

Extra → PRCD-Test → voir page suivante

Extra → PRCD-Test → véase la página siguiente

Extra → PRCD-Test → vedi pagina seguente

Extra → PRCD-Test → zie volgende pagina

Extra → ΔU(ZLN) – E-Mobility – PRCD-Test

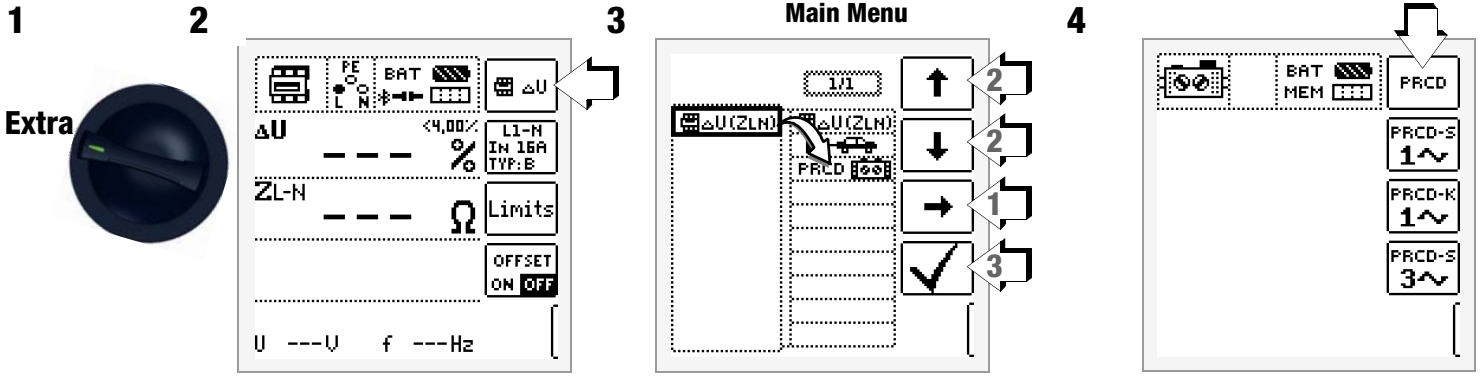

PRCD-Test @ PROFITEST | PRCD

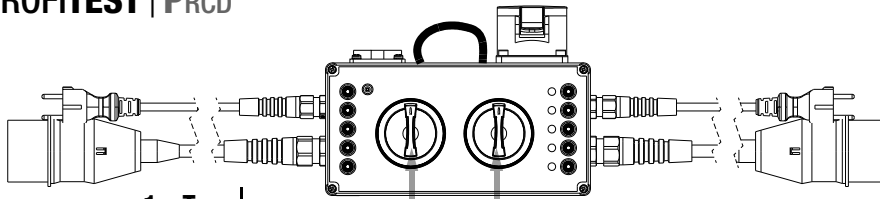

3-349-797-15

Bedienungsanleitung
Operating Instructions

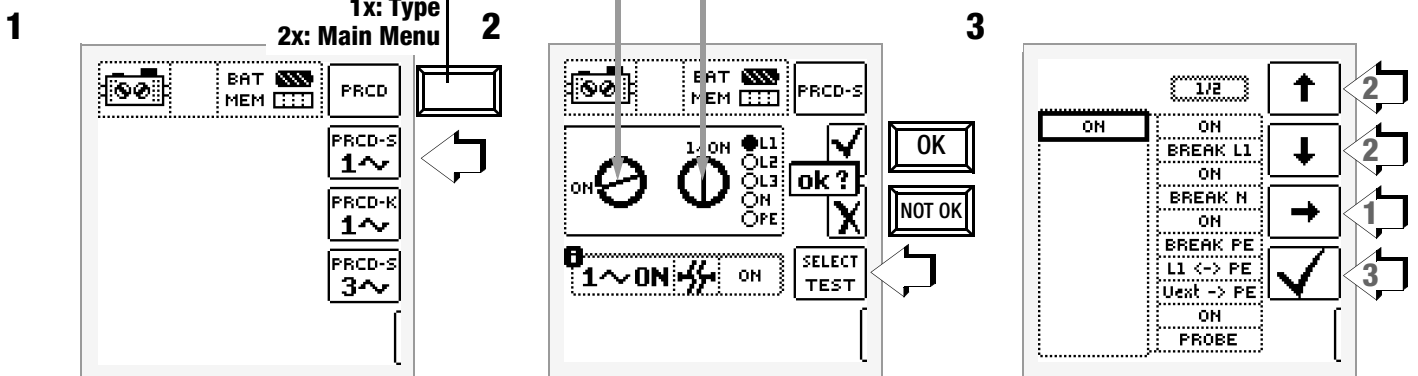

HV

no HV-Module, no Function

PROFITEST PRIME AC

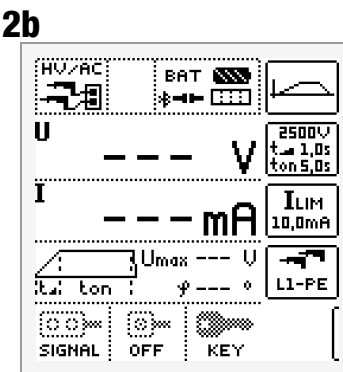
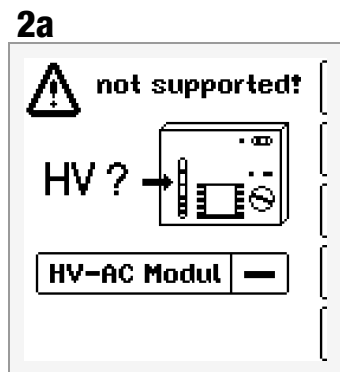

115V~/230V~
50 Hz ... 60 Hz

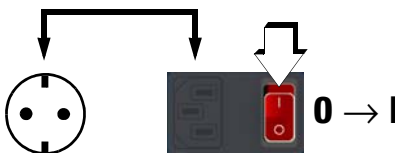

3-349-933-xx

Bedienungsanleitung
Operating Instructions
Istruzioni per l'uso

AUTO

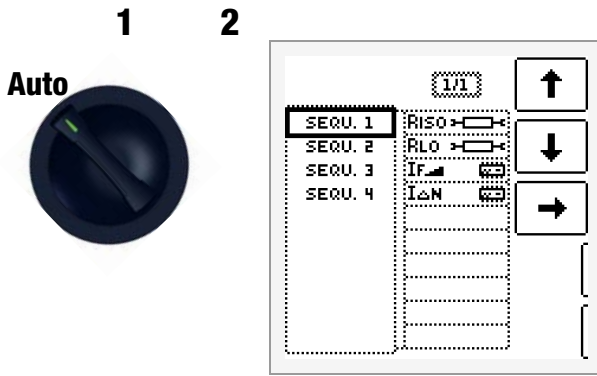

3-349-933-xx
 Bedienungsanleitung
 Operating Instructions
 Istruzioni per l'uso

- (D) **1 Ausschalten**
- (GB) **Switching off**
- (F) **Désactivation**
- (E) **Apagar**
- (I) **Spegnere**
- (NL) **Uitschakelen**

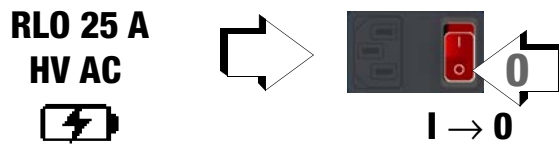
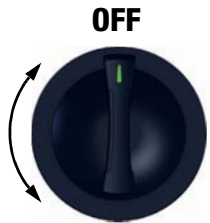

- (D) **Sicherungen**
- (GB) **Fuses**
- (F) **Fusibles**
- (E) **Fusibles**
- (I) **Fusibili**
- (NL) **Zekeringen**

MAINS / Netzversorgung

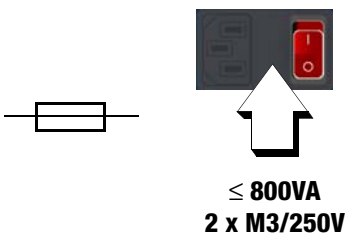

MEASURING CIRCUITS / Messkreis

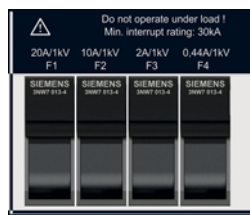

F1? F2? F3?

F1? F2? F4?

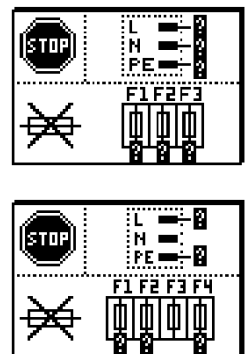

D

GB

F

E

I

NL

Anschlüsse

Sockets

Connexions

Conexiones

Collegamenti

Aansluitingen



Z502F/Z751G
Barcode/RFID-Leser
Barcode/RFID scanner
Lecteur de codes à barres
Lector de códigos de barras
Lettores codici a barre
Barcodelezer

RS232



PROFITEST CLIP: 0,1 ... 25 mA
WZ12C*: 1 mA ... 15 A
 1 A ... 150 A
Z3512A*: 0 ... 1/100/999 A
METRAFLEX P300*: 3/30/300 A

* nur mit Adapter Z506J
 only with adapter Z506J
 uniquement avec l'adaptateur Z506J
 solamente con adaptador Z506J
 solo con adattatore Z506J
 alleen met adapter Z506J

I/L/AMP $\leq 1V$

I-SK4 (Z506T) / I-SK12 (Z506U)

1(L) – L1

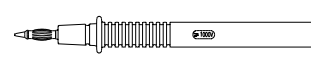

SK4-L (Z506L) / SK12-L (Z5060)

2(N) – L3

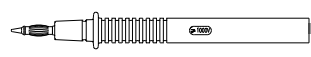

SK4-N (Z506N) / SK12-N (Z506M)

3(PE) – L2

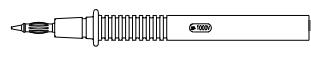

SK4-PE (Z506P) / SK12-PE (Z506R) / SK25-PE (Z506S)

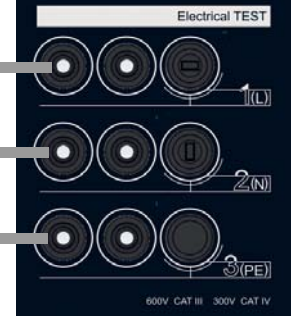

D

GB

F

E

I

NL

Gedruckt in Deutschland Änderungen vorbehalten

Printed in Germany Subject to change without notice

Imprimé en Allemagne Sous réserve de modifications

Impreso en Alemania Reservados todos los derechos

Stampato in Germania Con riserva di modifiche

Gedruckt in Duitsland Wijzigingen voorbehouden



GMC-I Messtechnik GmbH
 Südwestpark 15
 90449 Nürnberg • Germany

Telefon +49 911 8602-111
 Telefax +49 911 8602-777
 E-Mail info@gossenmetrawatt.com
 www.gossenmetrawatt.com